

INSTALLATION HANDBOOK:

Cross-linked Polyethylene (PEX) Hot and Cold Water-Distribution Systems

IMPORTANT NOTICE

The information in this manual was gathered from publicly available sources, including reports of tests conducted by various independent entities under the test conditions specified in the standards listed.

The contents of this manual are informational only and are not intended as an endorsement or warranty with respect to any product or system.

The Plastic Pipe and Fittings Association (PPFA) and its members have no responsibility for the design, administration, results or evaluation of any test. PPFA and its members make no warranties, express or implied, as to: the fitness of any product or system for any particular purpose; the suitability of any product or system for any specific application; or the performance of any product or system in actual construction.

No product or system should be used or installed without first reviewing all applicable plumbing or building code provisions and the manufacturer's installation or application instructions. Local code authorities and the product or system manufacturer should be consulted with respect to unresolved questions or uncertainties.

In the event there is any conflict or inconsistency between the content of this MANUAL and the applicable building or plumbing code and the manufacturer's installation or application instructions, the codes and the instructions shall be followed.

REVISION POLICY

The PPFA Flexible Polyolefin Hot and Cold Water Systems Product Line Committee is responsible for revision of the manual. All suggestions and recommendations for revisions shall be addressed to the Committee, which shall respond to them as promptly as reasonably possible.

The Committee shall review the manual in its entirety at least once every three (3) years.

Table of Contents

MANUAL CONTENT & USE	3
OTHER USES OF CROSS-LINKED POLYETHYLENE (PEX) TUBING	3
TUBING IDENTIFICATION	4
FITTING IDENTIFICATION	4
APPLICABLE STANDARDS	4
LIMITATIONS ON PEX USE	4
TUBING INSTALLATION PRACTICES	5
GENERAL INSTALLATION	5
BENDING THE TUBING	6
HANDLING & STORING TUBING	6
TUBING SUPPORTS	6
SELECTION & INSPECTION	6
SUPPORT SPACING & LOCATION	7
EXPANSION/CONTRACTION OF TUBING	7
HYDRAULIC SHOCK	8
THAWING TUBING SYSTEMS	8
CONNECTION (TRANSITION) TO OTHER PIPING MATERIALS	8
JOINING PROCEDURES UTILIZING METALLIC INSERT FITTING WITH A COPPER CRIMP RING (ASTM F 1807)	9
INCORRECT CONNECTIONS	9
MAKING A CONNECTION	9
TOOLS AND RINGS	10
DISINFECTION OF POTABLE WATER SYSTEMS	10
HYDROSTATIC TESTING & INSPECTION OF THE COMPLETED SYSTEM	10
BURIED WATER LINES	11
TRENCH PREPARATION	11
LAYING THE TUBING	11
BACKFILLING	11
MANIFOLD PLUMBING SYSTEMS	12
TECHNICAL DATA	13
FRICITION LOSSES	13

MANUAL CONTENT & USE

This Manual contains information on the installation of Cross-linked Polyethylene (PEX) tubing for hot and cold water distribution systems in residential and light commercial installations using tubing up to 1" in diameter.

Information in this manual shall not be separated as it is often interrelated.

Consult local codes for additional installation requirements.

For additional information contact:

Local officials having jurisdiction (for codes)

Manufacturer (for specific product information)

PPFA (for general installation instructions)

PEX Technology Center 1(800) 338-7732

OTHER USES OF CROSS-LINKED POLYETHYLENE (PEX) TUBING

- Hydronic Radiant Slab Heating
- Heat Pump Applications
- Other Uses With Similar Service Requirements

Note: Consult tubing manufacturer for details.

INSTALLATION HANDBOOK:
Cross-linked Polyethylene (PEX)
Hot and Cold Water-Distribution Systems

TUBING IDENTIFICATION

Check the PEX tubing for the proper ASTM identification marking.

Check for potable water listing (NSF International, Inc. [NSF-pw], or other recognized listing agency).

Use	ASTM Standard	Canadian Standard
Hot/Cold Water	F 876 or F 876/877/and Standard for Fittings	CSA B137.5

FITTING IDENTIFICATION

All metallic insert fittings shall be marked with:

Manufacturer's name or Trademark or other identification mark.

APPLICABLE STANDARDS

- **ASTM F 876** Specification for Cross-linked Polyethylene (PEX) Tubing.
- **ASTM F 877** - Specification for Cross-linked Polyethylene (PEX) Plastic Hot and Cold Water Distribution Systems.
- **ASTM F 1807** - Specification for Metal Insert Fittings Utilizing a Copper Crimp Ring for SDR 9 Cross-linked Polyethylene (PEX) Tubing
- **ASTM F 1960** - Specification for Cold Expansion Fittings with PEX Reinforcing Rings for use with Cross-linked Polyethylene (PEX) Tubing
- **CSA B137.5** - Cross-linked Polyethylene (PEX) Tubing Systems for Pressure Applications

LIMITATIONS ON PEX USE

- Do not use in applications where the temperature of the water could exceed 180° F at 100 psi unless specifically approved in the code, e.g., water heater relief line. See manufacturer's recommendations for higher operating temperatures at lower pressures.

- Do not use in any application where tubing will be exposed to direct sunlight.

- Do not allow tubing to come in extended contact with any of at least the commonly encountered construction materials listed below:

(This list is not all-inclusive.)
 Pipe thread sealing compounds;
 Fire wall penetration sealing compounds. *Exception: water soluble, gypsum-based caulking;*
 Petroleum-based materials such as: Kerosene Benzene Gasoline, Solvents, Fuel Oils, Cutting Oils, Asphaltic Paint, and Asphaltic Road Materials. Consult your tubing manufacturer if you have questions about these or any other materials not listed.

- Do not place any PEX tubing in heavily contaminated soils or other heavily contaminated environments.

- Do not use tubing with gouges, cuts, cracks, abrasions, evidence of chemical attack, or other defects, or tubing which has been crushed or kinked.

- Do not use in swimming pool piping systems.

Copper or brass fittings, when used in a PEX piping system, have the same limitations as copper or brass fittings used in plumbing or heating systems.

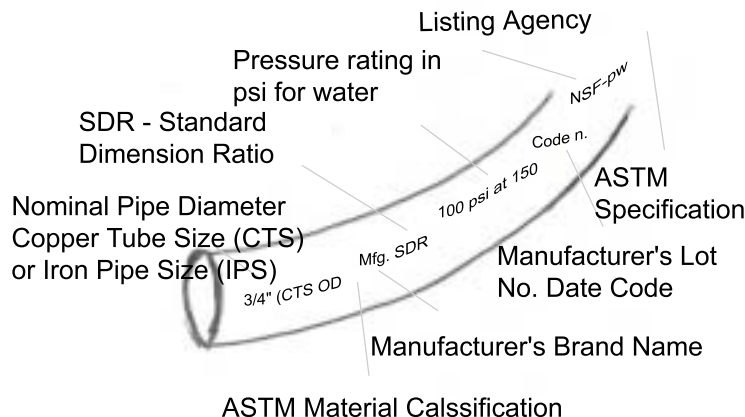

TUBING INSTALLATION PRACTICES

GENERAL INSTALLATION

Review all limitations on the use of cross-linked polyethylene tubing, and the fitting system you have selected to use.

- Keep tubing a minimum of 12 inches vertically or 6 inches horizontally from sources of high heat, such as recessed light fixtures, flue gas vents, or heating appliances.

- Do not install PEX tubing downstream of any point-of-use water heater or immersed coil heater in a boiler where the output temperature can exceed 180° F or closer than 6 inches upstream. Contact manufacturer for recommended metallic transition fittings.

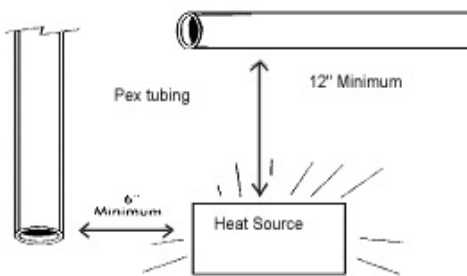

- Install a minimum 18 inches of metallic or other approved material piping between water heater and PEX tubing.

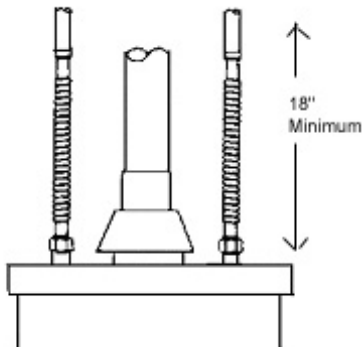

- Hose bibbs shall not be supported by PEX tubing. Hose bibbs shall be anchored to prevent strain on PEX tubing.

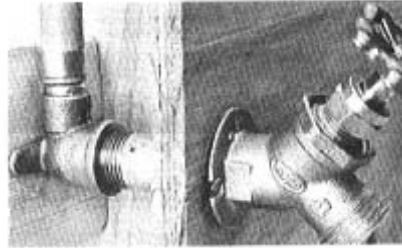

- Use only continuous length tubing (no fittings) when installing PEX under or within a slab. Protect PEX tubing with nonmetallic sleeves where it penetrates a slab or foundation. Protect tubing from nail damage where appropriate.

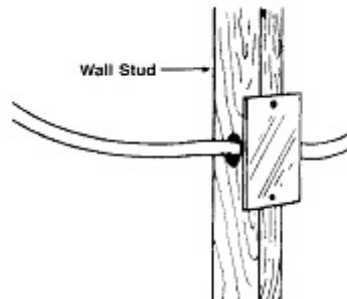

BENDING THE TUBING

Do not bend PEX tubing tighter than the following minimum recommended bending radii .

Table 1: Bending PEX

Tubing size (in.nominal)	Tubing O.D. (in.)	Minimum bending radius (in.) CTS
3/8	0.500	4
1/2	0.625	5
3/4	0.875	7
1	1.125	9

NOTE: If using tubing in coils, and bending the tubing against the coil direction, the minimum bending radius is 3 times the radius given above (e.g., 3/8" Tubing = 3 x 4 = 12").

HANDLING AND STORING TUBING



- Do not drag the tubing over rough terrain, rocks, or any surface that can cut, puncture, or damage the tubing wall.

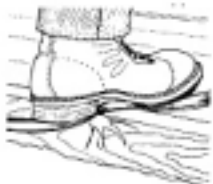

- Do not crush or kink the tubing.



- Inspect all tubing before and after installation. Cut out and replace all damaged sections.

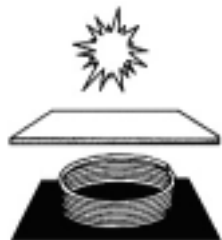

- Tubing shall be stored in a way to protect the system from mechanical damage (slitting, puncturing, etc.). Tubing should be stored undercover to keep it clean and avoid exposure to sunlight. Consult manufacturer for recommended limits for outside storage.

TUBING SUPPORTS: Selection and Inspection

Plastic hangers and straps are recommended, but metal supports which are designed for use with plastic tubing can be used.



Do not use supports that pinch or cut the tubing. Support should allow free tubing movement.

Inspect all supports prior to installation to ensure that sharp edges do not exist that can damage the tubing.

INCORRECT

CORRECT



SUPPORT SPACING & LOCATION

Nominal Tubing Diameter (in.)	Spacing (in.)
3/8, 1/2, 3/4, 1	32

Vertical tubing shall be supported at every floor (8-foot to 10-foot height) and at the mid floor guide between floors.

When penetrating metal studs, utilize properly-designed bushing or sleeving material on all penetrations to protect tubing.

Tubing must be installed without placing stress on the connection. Stress on connections frequently occurs when tubing is not properly strapped at changes of directions. See illustrations at right for proper methods.

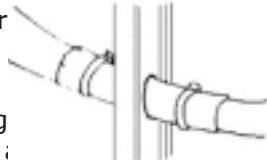

INCORRECT

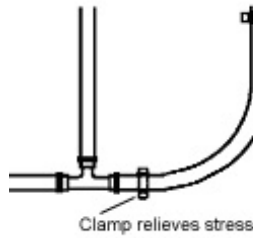

CORRECT

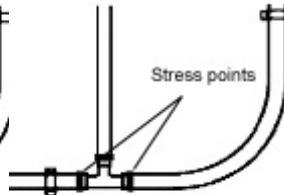

Examples of the use of straps when making bends directly from fittings.

CORRECT

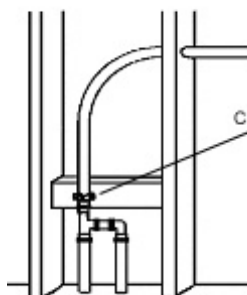

On cross brace

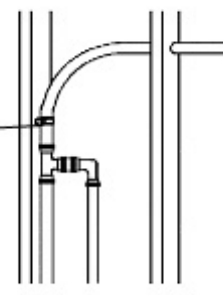

Along wall stud

EXPANSION / CONTRACTION OF TUBING

Do not pull tubing tight during installation and allow slack for tubing movement. This can cause excessive tensile forces on fittings and connections when tubing cools and contracts. Allow 1/8-inch slack/per foot of installed tubing.

Expansion can usually be accommodated by tubing's flexibility for sizes up to and including 1-inch size tubing.

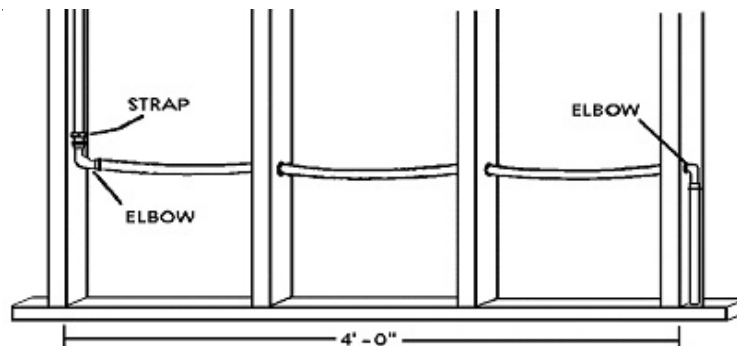

HYDRAULIC SHOCK

Table 2 below provides the maximum pressure that will occur from rapid closure of a valve in the various tubing systems at a given velocity. The faster the velocity, the greater the hydraulic shock.

For normal plumbing installations, water hammer arrestors are not necessary with a PEX tubing system.

In predominantly metal piping systems in which PEX is used, it may be necessary to install water hammer arrestors.

Table 2: Hydraulic Shock

Hydraulic shock (psi at 73 F)				
Velocity (fps)	4	6	8	10
PEX	58	87	116	145
Copper	200	300	400	505
Galv. Steel	240	360	475	595

THAWING TUBING SYSTEMS

PEX tubing systems should not be intentionally subjected to freezing.

Do not use open torch or excessive heat to thaw PEX tubing. Tubing failure or damage can result.

Heat (DO NOT USE A TORCH) must be applied directly to the frozen tubing section. Temperature on tubing shall not exceed 180° F.

Several suitable methods exist to thaw PEX tubing. They include:

- A commercial system which pumps heated water through a tube to the ice blockage, and returns the cooled water for reheating.
- Wet hot towels
- Hot water
- Hand-held hair dryer
- Low wattage electrical heating tape



CONNECTION (TRANSITION) TO OTHER PIPING MATERIALS

Solder copper transition fittings onto the copper pipe and allow to cool before connecting to PEX tubing. High heat (greater than 180° F) will damage the PEX tubing.

Do not use plastic male threads or non-gasketed female threads when making a connection to metal threads. Use only manufacturer's recommended transition fittings.

When making connections to CPVC pipe or fittings, use only approved transition fittings.

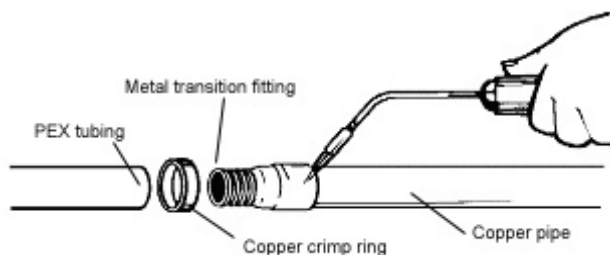

JOINING PROCEDURES UTILIZING METALLIC (BRASS OR COPPER INSERT FITTING WITH A BLACK COPPER CRIMP RING (ASTM F 1807)

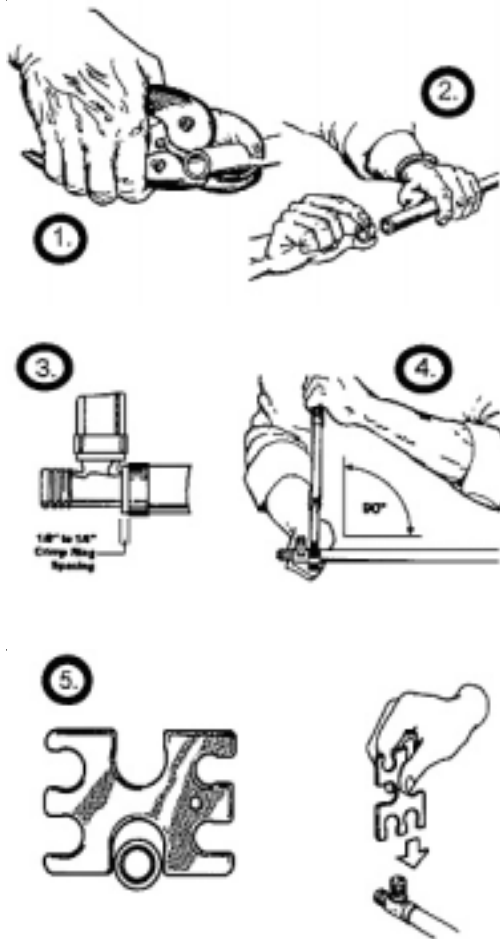

Making a Connection

Cut tubing squarely (1), remove burrs, and slip the copper crimp ring (2) onto the tube.

Insert fitting into tube to the tube stop (3); do not apply lubricant or pipe dope on the insert fitting. Position crimp ring 1/8-inch to 1/4-inch from end of tubing. To prevent ring from moving, squeeze the ring slightly with your fingers or a pair of pliers.

Center crimping tool jaws over the ring (4). Crimp ring shall be perpendicular to center radius of tubing. Keeping both ring and tool square with tube, close the tool completely. **DO NOT CRIMP TWICE.**

It is recommended that each crimped ring be checked with the appropriate GO NO/GO gauge (5). Slip gauge squarely over the crimped ring. If the "GO" slot of the gauge doesn't fit across the crimped ring, the diameter of the ring is too large and the fitting must be cut out. **DO NOT RECRIMP.** If the "NO/GO" slot of the gauge fits across the crimped ring, the diameter of the ring is too small and the fitting must be replaced. Cut out the ring and fitting, and replace them.

INCORRECT CONNECTIONS

The consequence of not following correct procedures is a potential for leaks. Incorrect fittings shall be cut out and replaced.

1. Ring crimped over end of tube. **Result: Doesn't cover enough ribs.**
2. Tool not at 90 degrees to tube when crimped. **Result: Insufficient rib coverage; tubing dented.**
3. Ring not completely covered by crimp tool. **Result: Ring distortion, non-uniform crimp.**
4. Tubing not cut squarely. **Result: Insufficient rib coverage.**
5. Ring too far from pipe end. **Result: Insufficient rib coverage.**

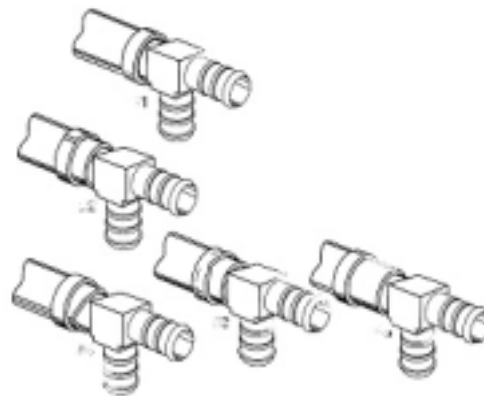

TOOLS AND RINGS

- Use tools recommended by fitting and tubing manufacturers.
- All tools must make a full-circle crimp.
- Check tool adjustment at least daily and readjust as necessary.
- Use only black colored copper crimp rings designed for this PEX system.

Full-circle crimp tool

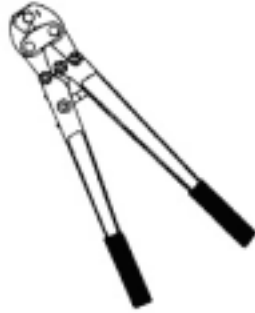

Go, no-go gauge

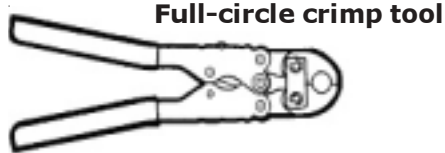

Full-circle crimp tool

Tubing cutter



HYDROSTATIC TESTING AND INSPECTION OF THE COMPLETED SYSTEM

- Test system with water pressure. Use of an air pump to maintain pressure on a water-filled piping system is acceptable.
- Test pressure shall be at least equal to the expected working pressure (main pressure), but not less than 100 psi and not greater than 225 psi at 73° F.
- Do not test with compressed air or gas.
- Test duration should not be less than 15 minutes.
- Do not allow water in system to freeze.

DISINFECTION OF POTABLE WATER SYSTEMS

If disinfection of the system is required by code, and the conditions are not specified, the following procedures can be used.

Chlorine Concentration	Disinfection Period	Authority
50 to 100 ppm	3 hours	AWWA*
50 ppm	6 hours	SBCCI**

*American Water Works Association
 **Southern Building Code Congress International

Use one of the recommendations above.

Premix the solution before injection into the system.

Thoroughly flush all lines of the system at the end of the disinfection period. Failure to do so may damage the plumbing system.

BURIED WATER LINES

Trench Preparation

Trench bottom shall be solid with no hollows, lumps, rocks, or other materials that could damage the tubing.

Laying the Tubing

■ Tubing should be laid with sufficient slack (snaking) to accommodate any contraction due to cooling prior to backfilling. Tubing will expand or contract approximately 1 inch in length for each 10° F change in tubing temperature for each 100 feet of tubing.

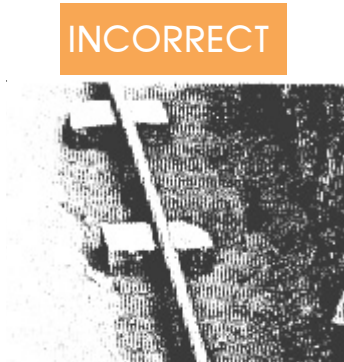
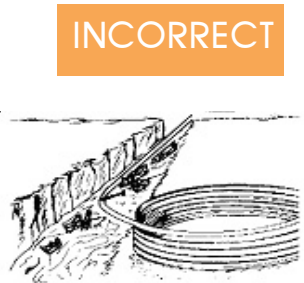

■ Do not use blocking for support, or to change the tubing's elevation.

■ Minimum bending radius requirements for PEX tubing shall be followed. See "Bending the Tubing" Table, Page 6.

■ Inspect tubing for damage. Remove and replace damaged sections.

■ In poor soil conditions, such as mud, rock, black gumbo, or clay, it is necessary to excavate deeper and use good clean fill or granular fill to smooth the trench bottom.

Backfilling

■ Do not use clay, silt, or rocky backfill. Remove the construction materials or foreign objects from trench prior to backfilling.

■ The tubing and fittings should be surrounded with good clean fill, or sand, or river run gravel of 1/2-inch maximum particle size.

■ Compact the initial backfill around the tubing to provide adequate tubing support and prevent settlement. It is particularly important to adequately compact the soil around the tap connection.

■ It is recommended that the tubing be pressurized with water prior to backfilling to reveal any damage.

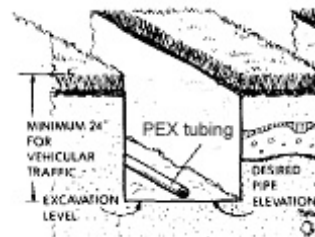

Satisfactory soil conditions, above. Unsatisfactory soil conditions, below, with additional fill materials as required. Both typical trench cross-sections are acceptable.

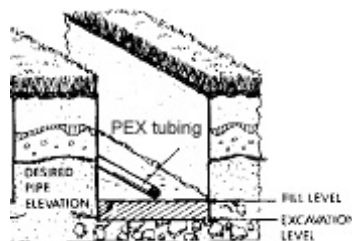

MANIFOLD PLUMBING SYSTEMS

The parallel manifold plumbing concept is relatively simple. Each faucet or water outlet is fed by its own dedicated line which runs from a central manifold. By providing each outlet with its own distribution line, the system offers quieter water flow, more balanced water pressure, a dramatic reduction in the number of fittings required, and the ability to save both water and energy, versus traditional system designs.

The following information applies to a PEX tubing plumbing manifold system in addition to the general limitations and installation information on PEX tubing and fittings in this manual.

- Manifolds can be installed in a horizontal or vertical position.
- In larger installations, remote manifolds may be used to handle groups of remote outlets.
- Each faucet or water outlet is fed by its own dedicated line from the manifold, which may be located near the water supply or water heater.
- Tubing shall be run continuously and as directly as possible between fixture and manifold locations. Approved fittings may be used to repair kinked or damaged PEX distribution lines, or to add to a distribution line that was mistakenly cut too short during installation. Excessive use of fittings is unnecessary.
- Shutoff valves can be placed at the manifold.
- Tubing shall not be pulled tight. Leave slack to allow for expansion and contraction.

- Install tubing cautiously to avoid binding, kinking, or abrasion.
- Leave excess tubing at the beginning and end of runs for connection to fixtures and the manifolds.
- When running lines to a group of fixtures, they may be bundled together, but must be bundled loosely enough to allow individual tubing movement. Plastic ties may be used.
- Do not use tape when bundling tubing as it may restrict movement of tubing runs.
- When bundled lines pass through conventional structural members, cut a hole at the centerline of the member. Consult the applicable code for maximum allowable hole size.
- Identify and mark all lines at the manifold.

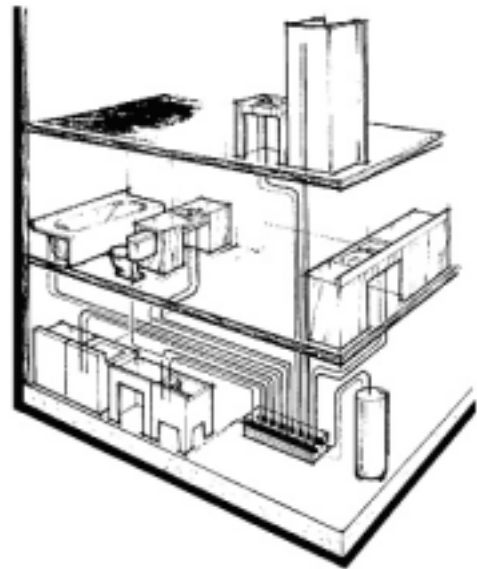

This drawing represents a typical manifold system.

TECHNICAL DATA

Table 3: Tubing Dimensions & Weights

Tubing Dimensions & Weights (ASTM F 876/877)		
Size (in.)	Outside diameter (in.)	Wt. (lbs./ft. of tubing)
3/8	0.500	0.0413
1/2	0.625	0.0535
3/4	0.875	0.1023
1	1.125	0.1689

FRICITION LOSSES

Insert fitting friction losses are shown in table below. Consult manufacturer for other fitting friction losses.

Table 4: Metal Insert Fitting Friction Loss

Type of Fitting	Equivalent Length of Tubing (ft.)			
	3/8" size	1/2" size	3/4" size	1" size
Coupling	2.9	2.0	0.6	1.3
Elbow 90°	9.2	9.4	9.4	10.0
Tee-branch	9.4	10.4	8.9	11.0
Tee-run	2.9	2.4	1.9	2.3

* 1" fittings have an increased total length

Tubing water flow rate, velocity, and frictional losses are given in the following table. Long-radius tubing bends have the same head loss as straight tubing.

Table 5: Friction Loss and Velocity vs. Flow Rate PEX Plumbing Tubing (CTS) (ASTM F-876/877)

Nominal Size Average ID	3/8" 0.350		1/2" 0.475		3/4" 0.671		1" 0.863	
GPM	F. Loss	Vel	F. Loss	Vel	F. Loss	Vel	F. Loss	Vel
1	7.0	3.33	1.6	1.81	0.3	0.96	0.1	0.55
2	25.4	6.67	5.8	3.62	1.1	1.81	0.3	1.10
3	53.9	10.00	12.2	5.43	2.3	2.72	0.7	1.65
4	91.8	13.34	20.8	7.24	3.9	3.63	1.1	2.19
5			31.4	9.05	5.9	4.54	1.7	2.74
6			44.0	10.86	8.2	5.44	2.4	3.29
7			58.6	12.67	10.9	6.35	3.2	3.84
8					14.0	7.26	4.1	4.39
9					17.4	8.17	5.1	4.94
10					21.1	9.07	6.2	5.48
11					25.2	9.98	7.4	6.03
12					29.6	10.89	8.7	6.58
13					34.3	11.79	10.1	7.13
14					39.4	12.70	11.6	7.68
15							13.2	8.23
16							14.8	8.78

NOTE:
 Friction Loss based on Hazen-Williams Formula ($C = 150$)
 CTS Tubing manufactured per ASTM F-876/877
 Friction Loss-psi per 100 ft. of tubing
 Velocity (VEL) feet per second